

MOTOR

Modelo	Isuzu AR-4JJ1X
Tipo	4-tiempos refrigerado por agua, inyección directa Common rail
Aspiración	Turbo de geometría variable con intercooler, EGR refrigerado
Post-tratamiento	Sistema DOC y SCR
N.º de cilindros	4
Potencia nominal	
ISO 14396	78,5 kW a 2.000 min ⁻¹
ISO 9249, neta	74,9 kW a 2.000 min ⁻¹
SAE J1349, neta	74,9 kW a 2.000 min ⁻¹
Par motor máximo	375 Nm a 1.800 min ⁻¹
Cilindrada	2,999 L
Diámetro x carrera	95,4 mm x 104,9 mm
Baterías	2 x 12 V/58 Ah

SISTEMA HIDRÁULICO

Bombas hidráulicas

Bombas principales	2 bombas de pistones axiales de caudal variable
Caudal máximo de aceite	2 x 117 L/min
Bomba de pilotaje	1 bomba de engranajes
Caudal máximo de aceite	33,6 L/min

Motores hidráulicos

Traslación	2 motores de pistones axiales de caudal variable
Giro	1 motor de pistón axial

Ajuste de la válvula de descarga

Circuito del implemento	34,3 MPa
Circuito de giro	32,3 MPa
Circuito de translación	34,3 MPa
Circuito de pilotaje	3,9 MPa
Potencia extra	36,3 MPa

Cilindros hidráulicos

	Cantidad	Diámetro de la camisa	Diámetro del vástago
Pluma	2	105 mm	70 mm
Balancín	1	115 mm	80 mm
Cazo	1	100 mm	70 mm
Posicionamiento *	1	140 mm	95 mm

* : Para pluma de 2 piezas

ESTRUCTURA SUPERIOR

Estructura giratoria

Chasis en forma de D para mayor resistencia a la deformación.

Mecanismo de giro

Motor de pistón axial con engranaje de reducción planetario sumergido en aceite. La corona de giro tiene una sola pista. El freno de giro es del tipo disco aplicado por muelle/liberado hidráulicamente.

Velocidad de giro	13,7 min ⁻¹
Par de giro	33 kNm

Cabina del operador

Espaciosa cabina independiente, de 1.005 mm de ancho por 1.675 mm de alto, conforme con las normas ISO*.

* International Organization for Standardization

ESTRUCTURA INFERIOR

Cadenas

Estructura inferior de tipo autoportante. Bastidor central soldado con materiales seleccionados.

Bastidor lateral soldado al central. Rodillos, ruedas guía y cabilla sellados con retenes flotantes.

Tejas de triple arista fabricadas en aleación laminada templada por corrientes de inducción.

Bulones de unión termotratados con retén anti suciedad. Tensores hidráulicos de la cadena (mediante grasa) con amortiguadores de muelles.

Número de rodillos y tejas a cada lado

Rodillo superior	1
Rodillos inferiores	7
Tejas	44
Protector de cadena	1

Mecanismo de translación

Cada cadena está impulsada por un motor de pistón axial de 2 velocidades. El freno de estacionamiento es del tipo disco aplicado por muelle/liberado hidráulicamente.

Sistema de transmisión automática: Cortas-Largas.

Velocidades de desplazamiento	Cortas: de 0 a 5,5 km/h
	Largas: de 0 a 3,3 km/h

Fuerza de tracción máxima	117 kN
---------------------------------	--------

Capacidad para superar pendientes	70% (35 grados) constante
---	---------------------------

NIVEL SONORO

Nivel sonoro en la cabina acorde con la norma ISO 6396

LpA 69 dB(A)

Nivel sonoro externo acorde con la norma ISO 6395 y

la directiva de la UE 2000/14/CE

LwA 99 dB(A)

CAPACIDADES DE LLENADO DE SERVICIO

Depósito de combustible	220,0 L
Refrigerante del motor	21,0 L
Aceite del motor	17,0 L
Mecanismo de giro	3,2 L
Mecanismo de translación (a cada lado)	4,0 L
Sistema hidráulico	155,0 L
Depósito de aceite hidráulico	60,0 L
Depósito DEF/AdBlue®	12,0 L

PESOS Y PRESIÓN GENERADA EN EL SUELO

Peso operativo y presión generada en el suelo

			ZAXIS 135US				ZAXIS 135US con hoja (opcional)			
Tipo de pluma			Monobloque		2 piezas		Monobloque		2 piezas	
Tipo de teja	Ancho de la teja	Longitud del balancín	kg	kPa	kg	kPa	kg	kPa	kg	kPa
Triple arista	500 mm	2,10 m	13.900	44	14.400	45	15.000	47	15.500	48
		2,52 m	14.000	44	14.500	45	15.000	47	15.500	49
		3,01 m	14.000	44	14.500	46	15.100	47	15.600	49
	600 mm	2,10 m	14.100	37	14.600	38	15.200	40	15.700	41
		2,52 m	14.200	37	14.700	38	15.200	40	15.700	41
		3,01 m	14.200	37	14.700	39	15.300	40	15.800	41
	700 mm	2,10 m	14.400	32	14.900	33	15.400	35	15.900	36
		2,52 m	14.400	32	14.900	33	15.400	35	15.900	36
		3,01 m	14.500	32	15.000	34	15.500	35	16.000	36
Pad	500 mm	2,10 m	13.800	43	14.300	44	14.800	46	15.300	48
		2,52 m	13.800	43	14.300	44	14.800	46	15.300	48
		3,01 m	13.900	43	14.400	45	14.900	46	15.400	48

Incluyendo 0,50 m³ (ISO con colmo), peso del cazo (410 kg) y contrapeso (3.520 kg).

Peso de la máquina básica y anchura total

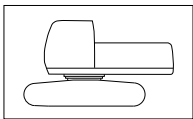

A excepción del implemento combustible, aceite hidráulico, refrigerante, etc. Incluye el contrapeso.

ZAXIS 135US

		ZAXIS 135US		ZAXIS 135US con hoja (opcional)	
Tipo de teja	Ancho de la teja	Peso	Anchura total	Peso	Anchura total
Triple arista	500 mm	11.200 kg	2.490 mm	12.200 kg	2.490 mm
	600 mm	11.400 kg	2.590 mm	12.500 kg	2.590 mm
	700 mm	11.700 kg	2.690 mm	12.700 kg	2.690 mm
Pad	500 mm	11.100 kg	2.490 mm	12.100 kg	2.490 mm

Peso de los componentes

	Peso
Contrapeso	3.520 kg
Pluma monobloque (con cilindro hidráulico del balancín y cilindro hidráulico de la pluma)	1.320 kg
Pluma de 2 piezas (con cilindro hidráulico del balancín y cilindro hidráulico de la pluma)	1.820 kg
Balancín de 2,10 m (con cilindro hidráulico del cazo)	550 kg
Balancín de 2,52 m (con cilindro hidráulico del cazo)	600 kg
Balancín de 3,01 m (con cilindro hidráulico del cazo)	670 kg
Cazo de 0,50 m ³	410 kg

FUERZA DE EXCAVACIÓN DEL CAZO Y EL BALANCÍN

		ZAXIS 135US		
Longitud del balancín		2,10 m	2,52 m	3,01 m
Fuerza de arranque del cazo* ISO		104 kN		
Fuerza de arranque del cazo* SAE: PCSA		91 kN		
Fuerza de penetración del balancín* ISO		77 kN	69 kN	61 kN
Fuerza de penetración del balancín* SAE: PCSA		74 kN	67 kN	60 kN

* Con aumento de potencia

RANGOS DE TRABAJO: PLUMA MONOBLOQUE

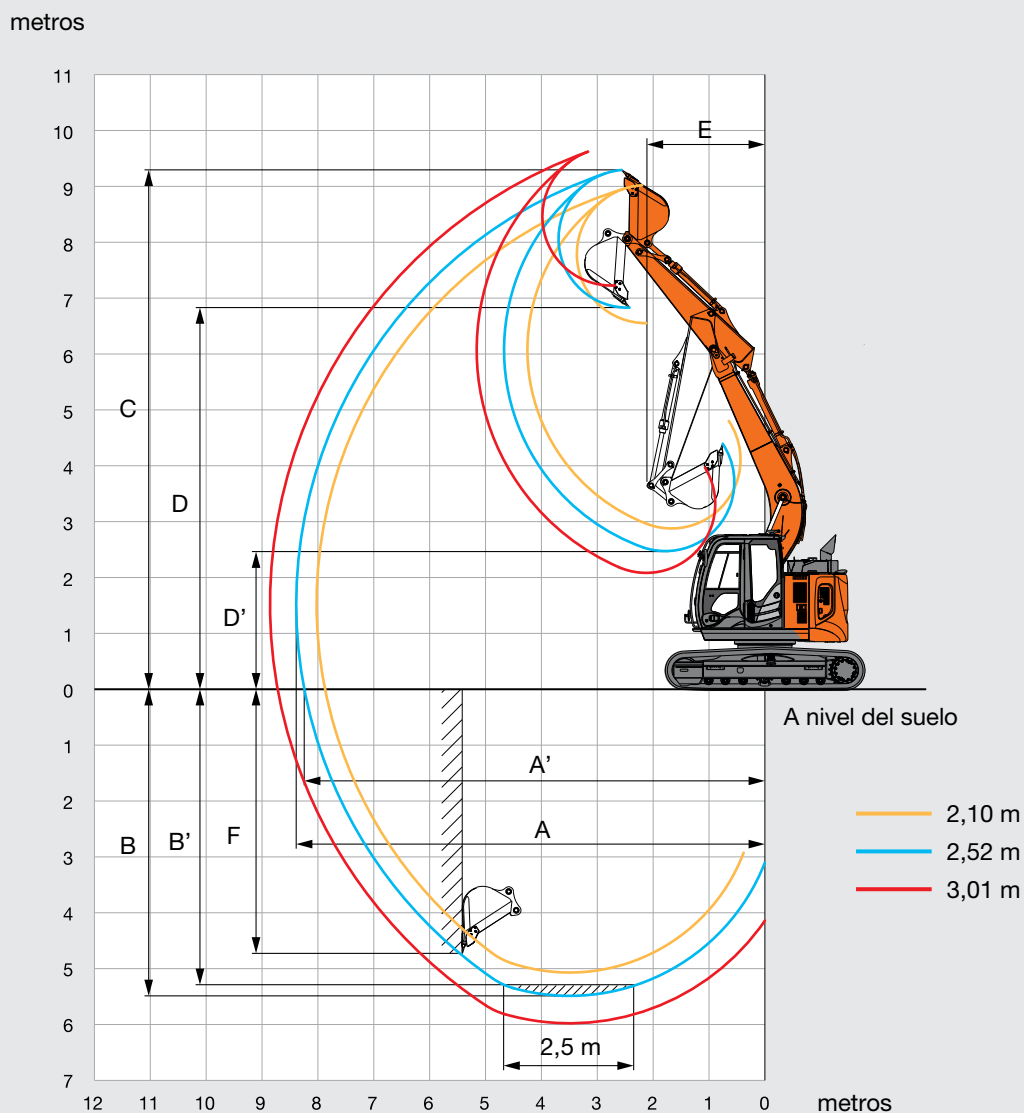

Unidad: mm

	ZAXIS 135US		
	Pluma monobloque		
Longitud del balancín	2,10 m	2,52 m	3,01 m
A Alcance máximo de excavación	8.020	8.390	8.860
A' Alcance máximo de excavación (en el suelo)	7.870	8.240	8.720
B Profundidad máxima de excavación	5.070	5.490	5.980
B' Profundidad máxima de excavación para un nivel de 2,5 m	4.820	5.270	5.790
C Altura máxima de corte	9.020	9.290	9.690
D Altura máxima de vertido	6.550	6.830	7.220
D' Altura mínima de vertido	2.870	2.470	2.080
E Radio mínimo de giro	2.000	2.110	2.450
F Profundidad máxima de excavación en vertical	4.430	4.730	5.190

Excluida la altura de las aristas de la teja

RANGOS DE TRABAJO: PLUMA DE 2 PIEZAS

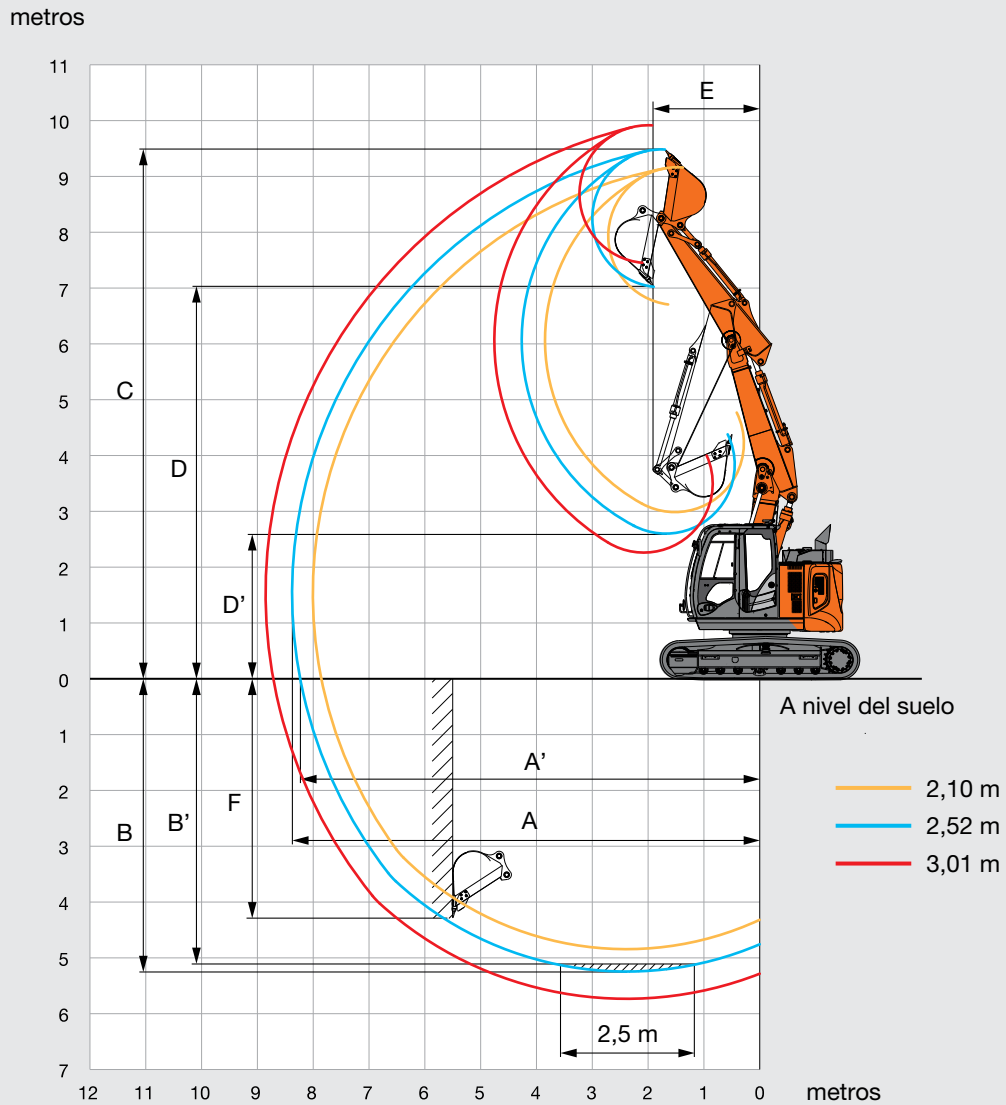

Unidad: mm

	ZAXIS 135US		
	Pluma de 2 piezas		
Longitud del balancín	2,10 m	2,52 m	3,01 m
A Alcance máximo de excavación	8.010	8.380	8.850
A' Alcance máximo de excavación (en el suelo)	7.860	8.240	8.720
B Profundidad máxima de excavación	4.850	5.250	5.740
B' Profundidad máxima de excavación para un nivel de 2,5 m	4.710	5.120	5.620
C Altura máxima de corte	9.160	9.480	9.920
D Altura máxima de vertido	6.700	7.020	7.450
D' Altura mínima de vertido	2.980	2.600	2.260
E Radio mínimo de giro	1.850	1.920	2.100
F Profundidad máxima de excavación en vertical	3.920	4.270	4.750

Excluida la altura de las aristas de la teja

DIMENSIONES

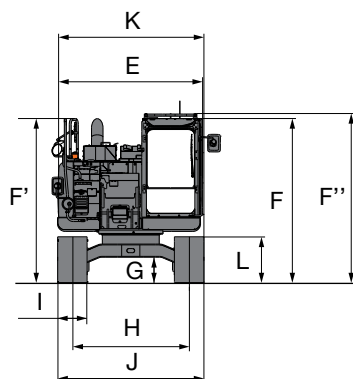

PLUMA MONOBLOQUE

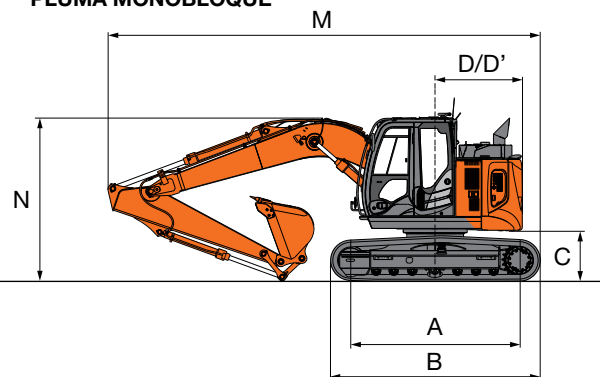

Hoja (opcional)

Unidad: mm

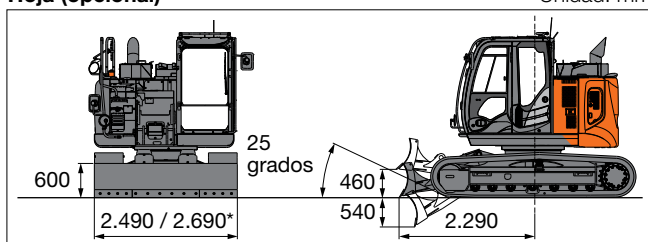

*G 600, G 700

PLUMA DE 2 PIEZAS

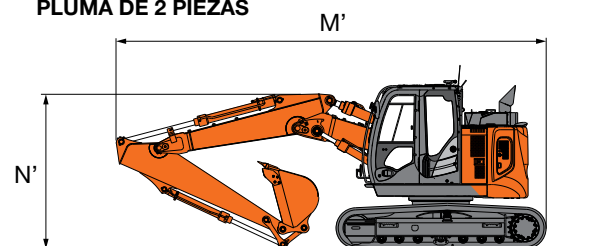

Unidad: mm

	ZAXIS 135US
A Distancia entre ruedas	2.880
B Longitud de la estructura inferior	3.580
* C Altura libre del contrapeso al suelo	840
D Radio de giro del extremo posterior	1.490
D' Longitud del extremo posterior	1.490
E Anchura total de la estructura superior	2.480
F Altura total de la cabina	2.790
F' Altura total de la barandilla	2.870
F'' Altura total de la barandilla (en la cabina)	2.870
* G Mínima altura libre al suelo	410
H Anchura entre los centros de la cadena	1.990
I Anchura de la teja	G 500
J Anchura de la estructura inferior	2.490
K Anchura total	2.490
*1 L Altura de la cadena con tejas de triple arista	790
PLUMA MONOBLOQUE	
M Longitud total	
Con balancín de 2,10 m	7.360
Con balancín de 2,52 m	7.370
Con balancín de 3,01 m	7.390
N Altura total de la pluma	
Con balancín de 2,10 m	2.790
Con balancín de 2,52 m	2.790
*2 Con balancín de 3,01 m	2.780
PLUMA DE 2 PIEZAS	
M' Longitud total	
Con balancín de 2,10 m	7.320
Con balancín de 2,52 m	7.310
Con balancín de 3,01 m	7.330
N' Altura total de la pluma	
Con balancín de 2,10 m	2.740
Con balancín de 2,52 m	2.640
*2 Con balancín de 3,01 m	2.790

*1 Excluida la altura de las aristas de la teja

*2 Las dimensiones con asterisco se corresponden con la posición del pasador de transporte.

G: Teja de triple arista

CAPACIDAD DE ELEVACIÓN

- Observaciones:
1. Los valores nominales se basan en ISO 10567.
 2. La capacidad de elevación no supera el 75% de la carga de vertido con la máquina en terreno firme y nivelado o el 87% de la capacidad hidráulica total.
 3. El punto de carga es la línea central del bulón de unión de la cuchara con el balancín.
 4. *Indica que la carga está limitada por la capacidad hidráulica.
 5. 0 m = Suelo.

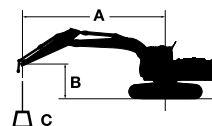











- A: Radio de carga
B: Altura del punto de carga
C: Capacidad de elevación



Para obtener las capacidades de elevación, reste el peso de la cuchara y el peso sobre el punto de enganche rápido a las capacidades de elevación.











ZAXIS 135US CON PLUMA MONOBLOQUE

 Sobrepasado por delante  Sobrepasado lateralmente o 360 grados Unidad: kg

Condiciones	Altura del punto de carga m	Radio de carga										Al máximo alcance		
		1,5 m		3,0 m		4,5 m		6,0 m		7,5 m		metros		
														
Pluma de 4,60 m Balancín de 2,10 m Contrapeso 3.520 kg Teja de 500 mm	6,0					*4.150	3.540					*2.980	2.940	5,01
	4,5			*5.030	*5.030	*4.310	3.490	*3.130	2.190			*2.710	2.140	6,07
	3,0			*7.490	6.100	5.000	3.300	3.190	2.140			*2.680	1.830	6,62
	1,5					4.760	3.080	3.100	2.060			2.580	1.720	6,79
	0 (suelo)			*5.300	*5.300	4.610	2.950	3.030	2.000			2.650	1.750	6,61
	-1,5	*5.000	*5.000	*8.660	5.360	4.580	2.920	3.030	2.000			3.000	1.980	6,05
	-3,0			*6.700	5.490	*4.600	3.000					*3.830	2.630	4,98
Pluma de 4,60 m Balancín de 2,52 m Contrapeso 3.520 kg Teja de 500 mm	6,0					*3.670	3.610					*2.430	*2.430	5,50
	4,5			*3.930	*3.930	*3.920	3.530	3.280	2.220			*2.260	1.940	6,48
	3,0			*6.620	6.280	*4.730	3.340	3.200	2.150			*2.250	1.680	6,99
	1,5			*6.790	5.570	4.790	3.100	3.100	2.050			*2.370	1.580	7,15
	0 (suelo)			*6.130	5.290	4.600	2.940	3.010	1.970			2.430	1.600	6,98
	-1,5	*4.720	*4.720	9.090	5.270	4.530	2.880	2.980	1.950			2.700	1.770	6,46
	-3,0	*8.600	*8.600	*7.440	5.380	4.580	2.920					3.460	2.260	5,47
Pluma de 4,60 m Balancín de 3,01 m Contrapeso 3.520 kg Teja de 500 mm	6,0					*3.140	*3.140	*2.360	2.250			*2.080	*2.080	6,10
	4,5					*3.440	*3.440	3.310	2.250			*1.950	1.710	6,99
	3,0			*5.270	*5.270	*4.280	3.390	3.220	2.160			*1.940	1.500	7,47
	1,5			*8.410	5.710	4.820	3.130	3.100	2.050	2.200	1.450	*2.040	1.410	7,62
	0 (suelo)			*6.630	5.280	4.590	2.920	2.990	1.950			2.180	1.430	7,46
	-1,5	*4.140	*4.140	*8.620	5.180	4.490	2.830	2.940	1.900			2.390	1.560	6,97
	-3,0	*7.200	*7.200	*8.140	5.250	4.500	2.840	2.970	1.930			2.920	1.900	6,07
-4,5			*5.390	*5.390	*3.260	3.000					*3.250	2.990	4,51	

ZAXIS 135US CON HOJA (LEVANTADA) Y PLUMA MONOBLOQUE











 Sobrepasado por delante  Sobrepasado lateralmente o 360 grados Unidad: kg

Condiciones	Altura del punto de carga m	Radio de carga										Al máximo alcance		
		1,5 m		3,0 m		4,5 m		6,0 m		7,5 m		metros		
														
Pluma de 4,60 m Balancín de 2,10 m Contrapeso 3.520 kg Teja de 500 mm	6,0					*4.150	3.780					*2.980	*2.980	5,01
	4,5			*5.030	*5.030	*4.310	3.730	*3.130	2.360			*2.710	2.310	6,07
	3,0			*7.490	6.530	4.970	3.540	3.170	2.310			*2.680	1.980	6,62
	1,5					4.720	3.330	3.080	2.230			2.560	1.860	6,79
	0 (suelo)			*5.300	*5.300	4.570	3.190	3.010	2.160			2.630	1.900	6,61
	-1,5	*5.000	*5.000	*8.660	5.780	4.540	3.160	3.010	2.160			2.980	2.140	6,05
	-3,0			*6.700	5.920	*4.600	3.240					*3.830	2.850	4,98
Pluma de 4,60 m Balancín de 2,52 m Contrapeso 3.520 kg Teja de 500 mm	6,0					*3.670	*3.670					*2.430	*2.430	5,50
	4,5			*3.930	*3.930	*3.920	3.770	3.250	2.390			*2.260	2.090	6,48
	3,0			*6.620	*6.620	*4.730	3.580	3.180	2.320			*2.250	1.820	6,99
	1,5			*6.790	6.000	4.750	3.340	3.070	2.220			2.360	1.710	7,15
	0 (suelo)			*6.130	5.720	4.560	3.180	2.990	2.140			2.410	1.740	6,98
	-1,5	*4.720	*4.720	9.020	5.700	4.500	3.120	2.960	2.120			2.680	1.930	6,46
	-3,0	*8.600	*8.600	*7.440	5.810	4.550	3.160					3.440	2.450	5,47
Pluma de 4,60 m Balancín de 3,01 m Contrapeso 3.520 kg Teja de 500 mm	6,0					*3.140	*3.140	*2.360	*2.360			*2.080	*2.080	6,10
	4,5					*3.440	*3.440	3.290	2.420			*1.950	1.850	6,99
	3,0			*5.270	*5.270	*4.280	3.630	3.200	2.330			*1.940	1.630	7,47
	1,5			*8.410	6.130	4.780	3.370	3.070	2.220	2.180	1.580	*2.040	1.540	7,62
	0 (suelo)			*6.630	5.710	4.550	3.160	2.970	2.120			2.160	1.560	7,46
	-1,5	*4.140	*4.140	*8.620	5.610	4.450	3.070	2.910	2.070			2.370	1.700	6,97
	-3,0	*7.200	*7.200	*8.140	5.680	4.460	3.080	2.950	2.100			2.900	2.070	6,07
-4,5			*5.390	*5.390	*3.260	3.240					*3.250	3.230	4,51	



CAPACIDAD DE ELEVACIÓN











ZAXIS 135US CON HOJA (APOYADA) Y PLUMA MONOBLOQUE

 Sobrepasado por delante  Sobrepasado lateralmente o 360 grados Unidad: kg











Condiciones	Altura del punto de carga m	Radio de carga										Al máximo alcance		
		1,5 m		3,0 m		4,5 m		6,0 m		7,5 m				metros
														
Pluma de 4,60 m Balancín de 2,10 m Contrapeso 3.520 kg Teja de 500 mm	6,0					*4.150	3.780					*2.980	*2.980	5,01
	4,5			*5.030	*5.030	*4.310	3.730	*3.130	2.360			*2.710	*2.310	6,07
	3,0			*7.490	6.530	*5.090	3.540	*4.210	2.310			*2.680	1.980	6,62
	1,5					*5.950	3.330	*4.510	2.230			*2.820	1.860	6,79
	0 (suelo)			*5.300	*5.300	*6.320	3.190	*4.620	2.160			*3.170	1.900	6,61
	-1,5	*5.000	*5.000	*8.660	5.780	*5.980	3.160	*4.150	2.160			*3.910	2.140	6,05
	-3,0			*6.700	5.920	*4.600	3.240					*3.830	2.850	4,98
Pluma de 4,60 m Balancín de 2,52 m Contrapeso 3.520 kg Teja de 500 mm	6,0					*3.670	*3.670					*2.430	*2.430	5,50
	4,5			*3.930	*3.930	*3.920	3.770	*3.540	2.390			*2.260	2.090	6,48
	3,0			*6.620	*6.620	*4.730	3.580	*3.980	2.320			*2.250	1.820	6,99
	1,5			*6.790	6.000	*5.690	3.340	*4.360	2.220			*2.370	1.710	7,15
	0 (suelo)			*6.130	5.720	*6.230	3.180	*4.580	2.140			*2.650	1.740	6,98
	-1,5	*4.720	*4.720	*9.100	5.700	*6.110	3.120	*4.370	2.120			*3.230	1.930	6,46
	-3,0	*8.600	*8.600	*7.440	5.810	*5.110	3.160					*3.800	2.450	5,47
Pluma de 4,60 m Balancín de 3,01 m Contrapeso 3.520 kg Teja de 500 mm	6,0					*3.140	*3.140	*2.360	*2.360			2.080	*2.080	6,10
	4,5					*3.440	*3.440	*3.350	2.420			1.950	1.850	6,99
	3,0			*5.270	*5.270	*4.280	3.630	*3.690	2.330			1.940	1.630	7,47
	1,5			*8.410	6.130	*5.330	3.370	*4.140	2.220	*2.530	1.580	2.040	1.540	7,62
	0 (suelo)			*6.630	5.710	*6.060	3.160	*4.470	2.120			2.250	1.560	7,46
	-1,5	*4.140	*4.140	*8.620	5.610	*6.170	3.070	*4.460	2.070			2.660	1.700	6,97
	-3,0	*7.200	*7.200	*8.140	5.680	*5.500	3.080	*3.700	2.100			3.580	2.070	6,07
-4,5			*5.390	*5.390	*3.260	3.240					3.250	3.230	4,51	

ZAXIS 135US CON PLUMA DE 2 PIEZAS











 Sobrepasado por delante  Sobrepasado lateralmente o 360 grados Unidad: kg

Condiciones	Altura del punto de carga m	Radio de carga										Al máximo alcance		
		1,5 m		3,0 m		4,5 m		6,0 m		7,5 m				metros
														
Pluma de 2 piezas Balancín de 2,10 m Contrapeso 3.520 kg Teja de 500 mm	7,5											*4.430	*4.430	2,86
	6,0			*4.790	*4.790	*4.290	3.600					*3.120	2.960	4,99
	4,5			*5.160	*5.160	*4.390	3.690	*3.140	2.170			*2.800	2.130	6,05
	3,0	*11.010	*11.010	*8.590	6.560	*4.960	3.580	3.250	2.180			*2.730	1.800	6,60
	1,5	*7.190	*7.190	*9.390	6.240	4.990	3.460	3.180	2.100			2.580	1.690	6,77
	0 (suelo)	*8.840	*8.840	*9.590	5.920	4.960	3.220	3.070	2.000			2.640	1.720	6,59
	-1,5	*13.350	*13.350	9.610	5.630	4.720	3.010	3.020	1.960			3.000	1.950	6,03
-3,0	*16.940	*16.940	*8.010	5.530	*3.740	2.970					*3.360	2.860	4,63	
Pluma de 2 piezas Balancín de 2,52 m Contrapeso 3.520 kg Teja de 500 mm	7,5			*4.300	*4.300							*3.260	*3.260	3,68
	6,0					*3.910	3.690					*2.540	*2.540	5,49
	4,5			*3.920	*3.920	*4.130	3.720	3.310	2.250			*2.330	1.920	6,47
	3,0			*7.420	6.600	*4.650	3.610	3.300	2.240			*2.300	1.650	6,98
	1,5	*11.700	*11.700	*9.370	6.280	4.990	3.530	3.220	2.150			2.370	1.540	7,14
	0 (suelo)	*8.900	*8.900	9.500	6.020	5.010	3.260	3.100	2.020			2.420	1.570	6,97
	-1,5	*11.880	*11.880	9.630	5.630	4.750	3.030	3.000	1.930			2.700	1.740	6,45
-3,0	*14.840	*14.840	*9.060	5.500	4.620	2.920					*2.760	2.290	5,36	
Pluma de 2 piezas Balancín de 3,01 m Contrapeso 3.520 kg Teja de 500 mm	7,5					*2.760	*2.760					*2.630	*2.630	4,56
	6,0					*3.320	*3.320	*2.440	2.240			*2.160	*2.160	6,10
	4,5					*3.510	*3.510	*3.150	2.330			*2.010	1.690	6,99
	3,0			*4.780	*4.780	*4.310	3.640	3.290	2.310			*1.980	1.470	7,47
	1,5	*11.040	*11.040	*9.190	6.330	4.980	3.460	3.230	2.210	2.200	1.420	*2.060	1.380	7,62
	0 (suelo)	*9.400	*9.400	*9.410	6.160	*4.930	3.310	3.140	2.060			2.170	1.390	7,46
	-1,5	*10.870	*10.870	9.520	5.660	4.810	3.080	3.000	1.930			2.380	1.520	6,97
-3,0	*13.850	*13.850	9.470	5.500	4.600	2.890	*2.650	1.900			*2.430	1.870	6,07	
-4,5											*6.730	*6.730	2,50	

ZAXIS 135US CON HOJA (LEVANTADA) Y PLUMA DE 2 PIEZAS
 Sobrepasado por delante
  Sobrepasado lateralmente o 360 grados
 Unidad: kg

Condiciones	Altura del punto de carga m	Radio de carga										Al máximo alcance				
		1,5 m		3,0 m		4,5 m		6,0 m		7,5 m		metros				
																
Pluma de 2 piezas Balancín de 2,10 m Contrapeso 3.520 kg Teja de 500 mm	7,5													*4.430	*4.430	2,86
	6,0			*4.790	*4.790	*4.290	3.830							*3.120	*3.120	4,99
	4,5			*5.160	*5.160	*4.390	3.900	*3.140	2.330					*2.800	2.290	6,05
	3,0	*11.010	*11.010	*8.590	6.920	*4.960	*3.790	3.230	2.350					2.710	1.950	6,60
	1,5	*7.190	*7.190	*9.390	6.620	4.960	3.710	3.150	2.270					2.550	1.830	6,77
	0 (suelo)	*8.840	*8.840	9.540	6.350	4.930	3.470	3.050	2.170					2.620	1.870	6,59
	-1,5	*13.350	*13.350	9.540	6.050	4.680	3.250	3.000	2.120					2.980	2.110	6,03
	-3,0	*16.940	*16.940	*8.010	5.960	*3.740	3.210							*3.360	3.090	4,63
Pluma de 2 piezas Balancín de 2,52 m Contrapeso 3.520 kg Teja de 500 mm	7,5			*4.300	*4.300									*3.260	*3.260	3,68
	6,0					*3.910	3.890							*2.540	*2.540	5,49
	4,5			*3.920	*3.920	*4.130	3.930	3.290	2.410					*2.330	2.070	6,47
	3,0			*7.420	6.940	*4.650	3.820	3.280	2.400					*2.300	1.790	6,98
	1,5	*11.700	*11.700	*9.370	6.670	4.960	3.770	3.200	2.320					2.350	1.680	7,14
	0 (suelo)	*8.900	*8.900	*9.450	6.450	4.970	3.500	3.070	2.190					2.400	1.710	6,97
	-1,5	*11.880	*11.880	9.550	6.060	4.720	3.270	2.970	2.100					2.670	1.890	6,45
	-3,0	*14.840	*14.840	*9.060	5.920	4.590	3.160							*2.760	2.480	5,36
Pluma de 2 piezas Balancín de 3,01 m Contrapeso 3.520 kg Teja de 500 mm	7,5					*2.760	*2.760							*2.630	*2.630	4,56
	6,0					*3.320	*3.320	*2.440	2.410					*2.160	*2.160	6,10
	4,5					*3.510	*3.510	*3.150	2.490					*2.010	1.830	6,99
	3,0			*4.780	*4.780	*4.310	3.840	3.280	2.470					*1.980	1.600	7,47
	1,5	*11.040	*11.040	*9.190	*6.700	*4.950	3.680	3.210	2.380	2.180	1.550			*2.060	1.510	7,62
	0 (suelo)	*9.400	*9.400	*9.360	6.590	*4.930	3.550	3.110	2.230					2.150	1.520	7,46
	-1,5	*10.870	*10.870	*9.490	6.090	4.770	3.320	2.970	2.100					2.360	1.660	6,97
	-3,0	*13.850	*13.850	9.400	5.930	4.560	3.130	*2.650	2.070					*2.430	2.040	6,07
-4,5													*6.730	*6.730	2,50	

ZAXIS 135US CON HOJA (APOYADA) Y PLUMA DE 2 PIEZAS
 Sobrepasado por delante
  Sobrepasado lateralmente o 360 grados
 Unidad: kg

Condiciones	Altura del punto de carga m	Radio de carga										Al máximo alcance				
		1,5 m		3,0 m		4,5 m		6,0 m		7,5 m		metros				
																
Pluma de 2 piezas Balancín de 2,10 m Contrapeso 3.520 kg Teja de 500 mm	7,5													*4.430	*4.430	2,86
	6,0			*4.790	*4.790	*4.290	3.830							*3.120	*3.120	4,99
	4,5			*5.160	*5.160	*4.390	3.900	*3.140	2.330					*2.800	2.290	6,05
	3,0	*11.010	*11.010	*8.590	6.920	*4.960	*3.790	*3.720	2.350					*2.750	1.950	6,60
	1,5	*7.190	*7.190	*9.390	6.620	*6.030	3.710	*4.030	2.270					*2.860	1.830	6,77
	0 (suelo)	*8.840	*8.840	*9.780	6.350	*6.250	3.470	*4.420	2.170					*3.180	1.870	6,59
	-1,5	*13.350	*13.350	*9.940	6.050	*6.260	3.250	*3.260	2.120					*3.160	2.110	6,03
	-3,0	*16.940	*16.940	*8.010	5.960	*3.740	3.210							*3.360	3.090	4,63
Pluma de 2 piezas Balancín de 2,52 m Contrapeso 3.520 kg Teja de 500 mm	7,5			*4.300	*4.300									*3.260	*3.260	3,68
	6,0					*3.910	3.890							*2.540	*2.540	5,49
	4,5			*3.920	*3.920	*4.130	3.930	*3.340	2.410					*2.330	2.070	6,47
	3,0			*7.420	6.940	*4.650	3.820	*3.520	2.400					*2.300	1.790	6,98
	1,5	*11.700	*11.700	*9.370	6.670	*5.650	3.770	*3.830	2.320					*2.400	1.680	7,14
	0 (suelo)	*8.900	*8.900	*9.700	6.450	*6.200	3.500	*4.240	2.190					*2.660	1.710	6,97
	-1,5	*11.880	*11.880	*9.810	6.060	*6.260	3.270	*4.100	2.100					*3.120	1.890	6,45
	-3,0	*14.840	*14.840	*9.060	5.920	*4.990	3.160							*2.760	2.480	5,36
Pluma de 2 piezas Balancín de 3,01 m Contrapeso 3.520 kg Teja de 500 mm	7,5					*2.760	*2.760							*2.630	*2.630	4,56
	6,0					*3.320	*3.320	*2.440	2.410					*2.160	*2.160	6,10
	4,5					*3.510	*3.510	*3.150	2.490					*2.010	1.830	6,99
	3,0			*4.780	*4.780	*4.310	3.840	*3.310	2.470					*1.980	1.600	7,47
	1,5	*11.040	*11.040	*9.190	*6.700	*5.200	3.680	*3.620	2.380	*2.570	1.550			*2.060	1.510	7,62
	0 (suelo)	*9.400	*9.400	*9.580	6.590	*6.140	3.550	*4.020	2.230					*2.260	1.520	7,46
	-1,5	*10.870	*10.870	*9.670	6.090	*6.160	3.320	*4.380	2.100					*2.640	1.660	6,97
	-3,0	*13.850	*13.850	*9.710	5.930	*5.800	3.130	*2.650	2.070					*2.430	2.040	6,07
-4,5													*6.730	*6.730	2,50	